

03 Jamb Detail  
1 : 5

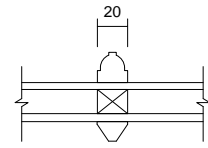

04 Glazing Bar Detail  
1 : 5

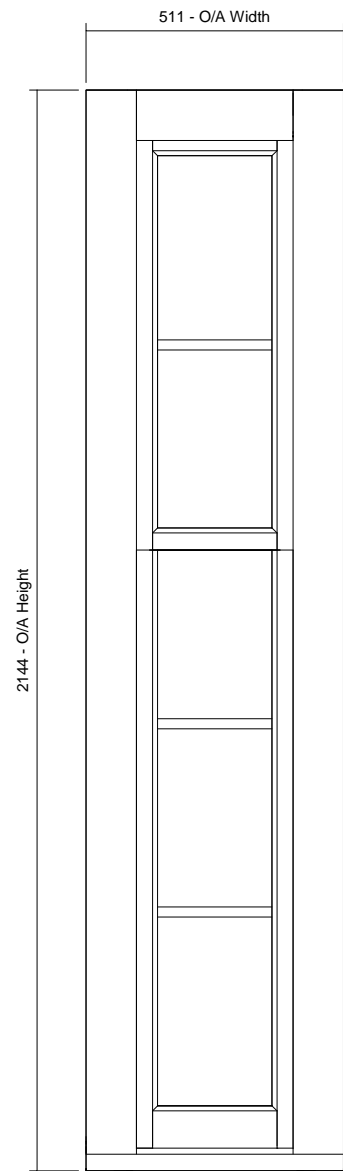

02 Front View  
1 : 15

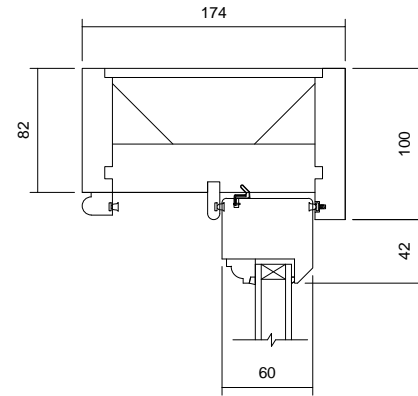

05 Head Detail  
1 : 5

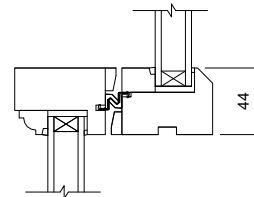

06 Meeting Rail Detail  
1 : 5

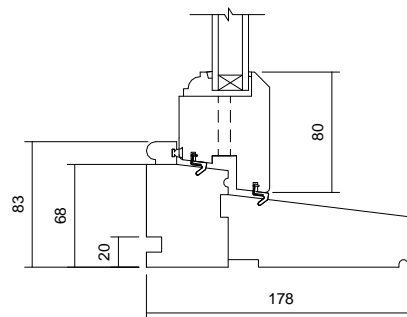

07 Cill Detail  
1 : 5

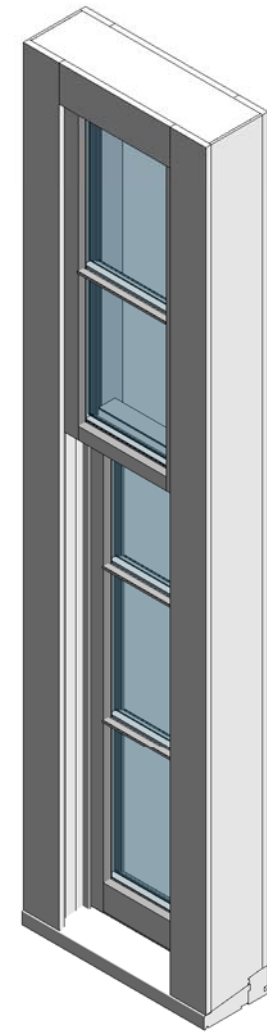

01 3D View

Window Schedule	
Height	Width
2144	511

NOTE! ELEVATION DRAWINGS VIEWED EXTERNALLY

 <p>Made-to-order timber windows and doors</p>	Drawing Number B1/23H		Drawn By DH
	Scale 1:5 & 1:15 @ A4	Revision	Date 26/09/16
	Customer		
	Project Box Sash 2144 x 511		
T 01277 353857 <a href="http://www.lomaxwood.co.uk">www.lomaxwood.co.uk</a>		© COPYRIGHT 2016 LOMAX-WOOD. ALL RIGHTS RESERVED	